

Spherical roller bearings, cylindrical and tapered bore

Principal dimensions			Basic load ratings		Speed ratings	Limiting speed	Designation
d	D	B	dynamic C	static C0	Reference speed		* SKF Explorer bearing
mm			kN		r/min		-
440	650	212	4987	9150	500	850	24088 ECAK30/W33 *

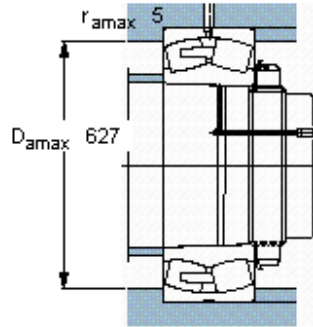
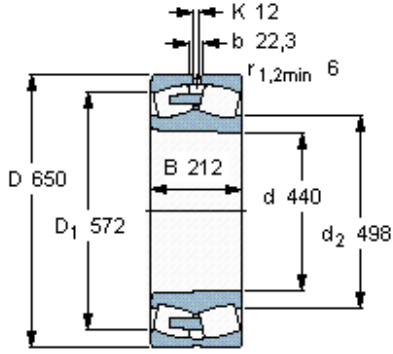

Tapered bore, taper
1: 30

Calculation factors

- e 0,3
- Y_1 2,3
- Y_2 3,4
- Y_0 2,2